

# Instruction Manual

## Magneto-electric Detector

### AP-981

#### ■ Precautions for use

- ① The AP-981 is protected against nitric acid fume concentrations up to 10% and is of explosionproof construction. However, care should be taken that it is not subjected to oil or other chemical substances. The level of protection is Class 7 and, the detector is not intended for use in applications which would continuously submerge it in water.
- ② The AP-981 features internal power supply polarity reversal protection so that if the power supply polarity is reversed power will not be applied. If this occurs, check the power supply wiring and correct this condition.

#### 1. Introduction

The AP-981 is an magneto-electric detector which uses a magnetic reluctance device and is suitable for rpm measurements from ultra-low speeds to high speeds.

Electromagnetic detectors use electromagnetic induction which results in a lowered output voltage at lower rpm speeds, making difficult measurements at low rpm and when the rotating body is actually stopped.

To solve this problem, the magneto-electric detector uses a magnetic reluctance device, permanent magnet, DC amplifier and voltage irregularator, all built into the detector to provide response to magnetic flux, by virtue of changes in resistance value in response to magnetic flux. This approach enables detection and output of a squarewave at speeds ranging from ultra-low rpm to high rpm.

The AP-981 conforms to Japan Industrial Standards C0920 for electrical machinery and wiring waterproofing (Class 7, marked IP X7), and, although it can not be used submerged, it can be used in environments which would occasionally subject it to such conditions.

#### 2. Operation

##### 2.1 Names of Parts (see Fig.1)

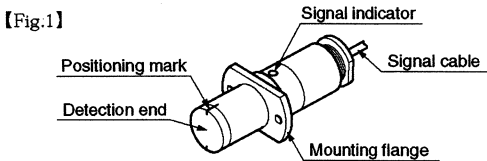

##### 2.2 Operation

###### 2.2.1 Mounting Fixture

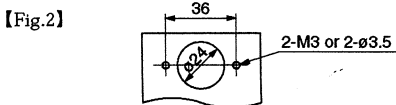

A mounting fixture as shown in Fig.2 should be prepared by the user. This fixture can be made of either magnetic or non-magnetic material. However, for magnetic material, having a thickness up to the positioning mark should be avoided. Also, when using the detector in a corrosive atmosphere, consideration must be given with respect to the fixture and screws as well.

To provide adjust of the gap between the detector and the detection gear, the mounting fixture should enable fine adjustment and should be mounted securely to prevent movement when vibrated.

###### 2.2.2 Detection Gear

The detection gear should be as follows.

Tooth shaped : Involute

Module : 1 to 3

Tooth width : 3 mm min.

Material : Magnetic (e.g. : S20C, SS400)

##### 2.2.3 Positioning

It is necessary to position the AP-981 properly with respect to the detection gear. Align the positioning mark with the center of the gear as shown in Fig.3. There are two marks on the top and the bottom grid, align for easy visibility. When aligning, be sure that the gear shaft and detector are perpendicular to one another.

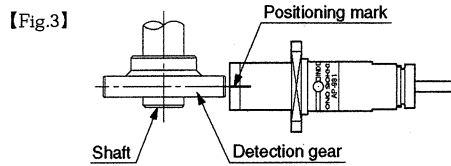

The detector center should be aligned to the gear center shaft as shown in Fig.4. If this is skewed, the detection distance will be reduced and, depending upon the gear rotation direction, the output signal pulses may actually be missed. Always, therefore, take extreme care in positioning correctly to obtain accurate mounting.

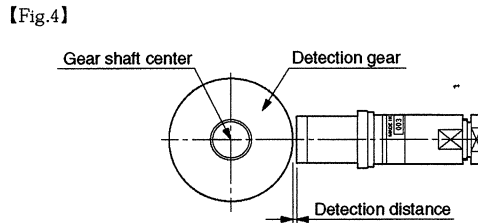

##### 2.2.4 Relationship of Detection Distance to Gear Module

The detection distance will vary depending upon the module of the detection gear used and will be greater, the higher is the module of the gear. The detection distance is also dependent upon temperature and, in cases in which a wide variation of ambient temperature is expected, the detector should be mounted as close as possible to the detection gear. The detection distance range indicated in Fig. 5 assumes an output waveform duty cycle 50% ± 20%.

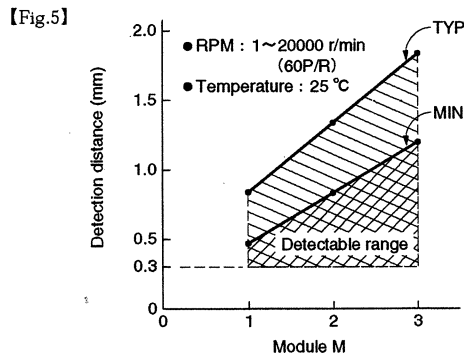

The magnetic materials, the influence of temperature will affect the detection distance as shown in Fig.6. For this reason, temperature changes should be minimized and the detection distance selected with enough reserve to allow for such changes.

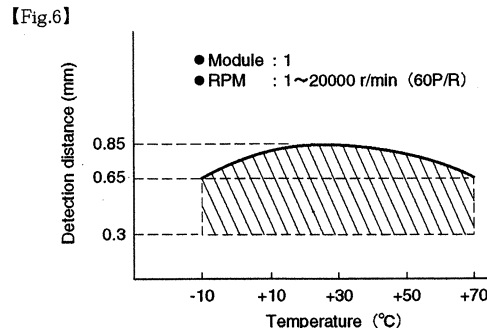

## 2.2.5 Signal Cable and Power Connections

[Fig.7]

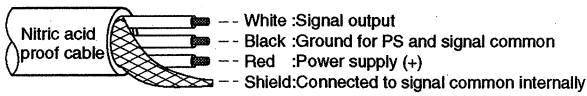

The power supply voltage should be 12 VDC  $\pm$  2 V.

Note that the tachometer "COM" terminal should be connected to "-" terminal of the DC power supply.

[Fig.8]

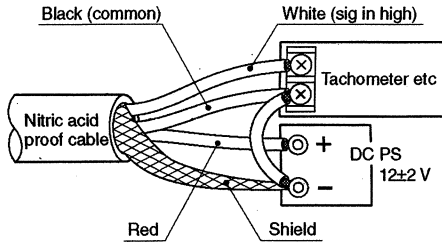

The signal cable is a directly output cable of approximately 1.9 m length. To extend this cable, use the arrangement shown in Fig.9. When doing this, care should be taken with nitric acid fumes when using a general-purpose cable and with the nitric acid fume-proof cable stripped section. If the shield lead is connected to the case or other parts, care is required as noise immunity may actually diminished.

[Fig.9]

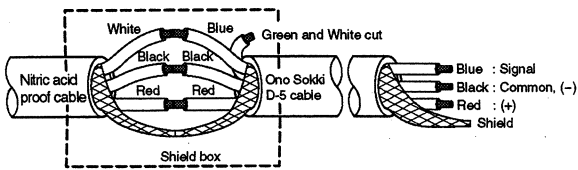

## 2.2.6 Signal Indicator

Mount the AP-981 with respect to the detection gear as described in Fig.3,4 and 5. When the detection gear is rotated, indicator on the AP-981 will flash. If the rotation speed of the gear is high, the indicator will appear to be on continuously. However, if rotated slowly by hand, the effect of the teeth of the gear can be seen to make the indicator flash. This indicator lights only when the output signal changes from a high level to a low level and does not light at the reverse direction change.

If the indicator does not light even though the gear is being turned, check the mounting position once again and / or reduce the distance between the detector and the gear.

## 2.2.7 Output Signal

After having achieved a normal mounting position and detection distance, the output waveform should have a duty cycle of  $50 \pm 30\%$ . This can be verified by using an oscilloscope or by measuring the average current value using a DC ammeter or similar instrument.

The output circuit is as shown in Fig.10.

If the distance is greater than 10 m, the resistance R1 should be adjusted within the range 1 k to 100 to obtain proper matching in order to prevent waveform distortion.

[Fig.10]

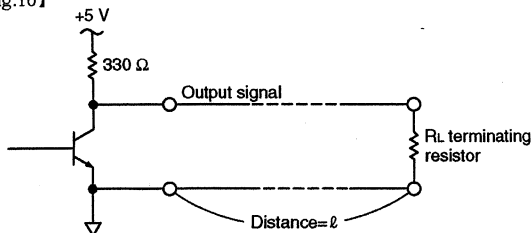

## 3. Specifications

Detection type	: Magnetic reluctance device
Measurement range	: 1 Hz to 20 kHz (using 60 P / R gear over the range of 1 to 20,000 r / min with an output wave form of $50\% \pm 30\%$ duty cycle)
Detection gear	: Magnetic material (module : 1 to 3, tooth width : 3 mm min)
Detection distance	: 0.3 to 0.85 mm (m = 1) 0.3 to 1.35 mm (m = 2) 0.3 to 1.85 mm (m = 3) m : module of gear
Power requirements	: 12 VDC $\pm$ 2 V (0.5 Vp-p max. Ripple)
Current consumption	: Approx. 30 mA (at 12 V / 25°C)
Output waveform	: Low level : 0.5 Vmax. High : 5 V $\pm$ 0.5 V (Rectangular wave with no load)
Output impedance	: Approx. 330 $\Omega$
Connectable load resistance	: Depends upon matching resistance
Signal cable length and connections	: Length: 1.9 m (One end unterminated) Red : + 12 V DC White : Signal output Black / Shield : 12 V DC and 0 V Power ground and signal output common
Protective circuit	: Polarity reversal and output shorting
Operating temperature range	: - 10°C to + 70°C - 10°C to + 50°C (with a nitric acid fume concentration of 10%)
Storage temperature range	: - 20°C to + 80°C
Maximum vibration (powered on)	: 1.2 mm double-sided amplitude at 30 Hz in X, Y and Z directions for one minute each
Maximum shock (unpowered)	: 490 m / s <sup>2</sup> in X and Y directions three times each
Dimensions	: See Section 4
Mass	: Approx. 130 g (including signal cable)
Outer surface material	: Polycarbonate
Accessories	: Instruction manual

## 4. Outside Drawing

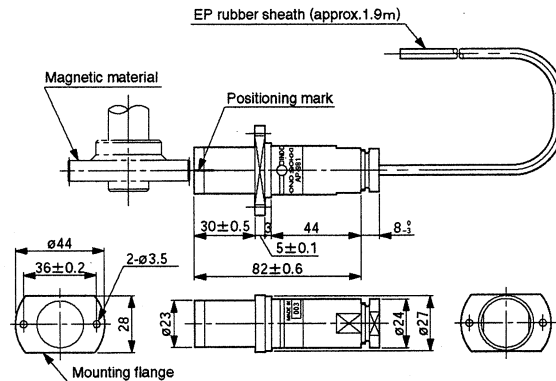

### Warranty

1. This product is covered by a warranty for a period of one year from the date of purchase.
  2. This warranty covers free-of-charge repair for defects judged to be the responsibility of the manufacturer, i.e., defects occurred while the product is used under normal operating conditions according to descriptions in this manual and notices on the unit label.
  3. For free-of-charge repair, contact either your sales representative or our sales office nearby.
  4. The following failures will be handled on a fee basis even during the warranty period.
    - (a) Failures occurring through misuse, mis-operation or modification.
    - (b) Failures occurring through mishandling (dropping) or transportation.
    - (c) Failures occurring through natural calamities (fires, earthquakes, flooding, and lightning), environmental disruption, or abnormal voltage.
- \* For repairs after the warranty period expired, contact your sales representative or our sales office nearby.

\*Outer appearance and specifications are subject to change without prior notice.  
HOME PAGE : <http://www.onosokki.co.jp/English/english1.htm>

## ONO SOKKI

U.S.A. & CANADA  
Ono Sokki Technology Inc.  
2171 Executive Drive, Suite 400, Addison,  
IL60101, U.S.A.  
Phone : 630-627-9700  
Fax : 630-627-0004

EUROPE  
Ono Sokki Mess-und Kontrollsysteme GmbH  
Im Vogelsang 1, D-71101 Schoenaich, Germany  
Phone : 07031-630203  
Fax : 07031-654249

P.R.CHINA  
Ono Sokki Beijing Office  
Beijing Jing Guang Center 3510, 1 lu Jia Lou,  
Chao Yang Qu, Beijing, P.R.China 100020  
Phone : 010-6597-3113  
Fax : 010-6597-3114

WORLD WIDE  
Ono Sokki Co., Ltd.  
1-16-1 Hakusan, Midori-ku, Yokohama 226-8507,  
Japan  
Phone : 045-935-3976  
Fax : 045-930-1906  
E-mail : [overseas@onosokki.co.jp](mailto:overseas@onosokki.co.jp)